



CA | **CALUMINIUM**
الشركة الكندية العالمية للألومنيوم

Speed, Quality, Innovation- Always.





EXPORT PROFILES

We have been successful in exporting to the Gulf, North Africa and Europe. Today, our export customers are return customers of which some are exclusively using our product lines. We are a growing factory, and we take pride in our product and efforts with the ambition of continued success in the surrounding markets.

قطاعات التصدير

لقد نجحنا في التصدير إلى منطقة الخليج وشمال أفريقيا وأوروبا. اليوم، عملاء التصدير لدينا يستخدمون حصريا خطوط الإنتاج الخاصة بنا. فمصنعنا ينمو بشكل سريع، ونحن نفخر في منتجاتنا وجهودنا وطموحنا في استمرار النجاح في الأسواق المحيطة

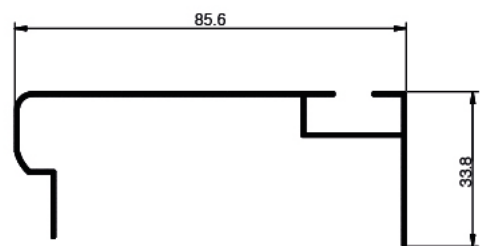

GRE 01
Weight: 0.431 KG/M

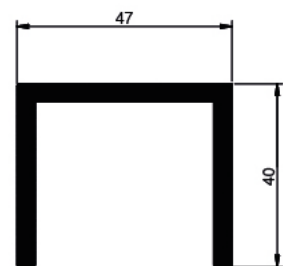

GRE 02
Weight: 1.285 KG/M

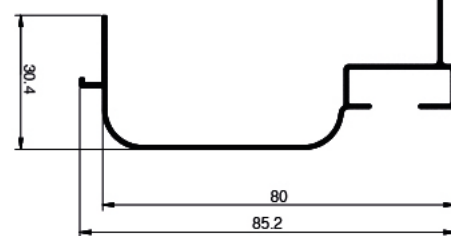

SOLAR 01
Weight: 0.408 KG/M

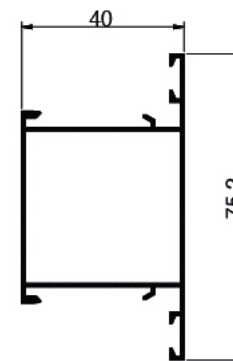

MR 479
Weight: 0.520 KG/M

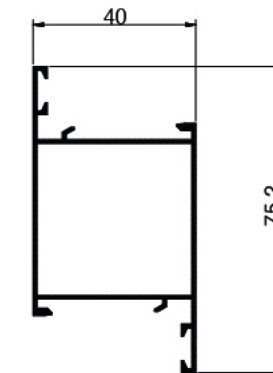

MR 458
Weight: 0.520 KG/M

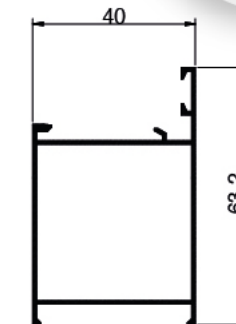

MR 140
Weight: 0.450 KG/M

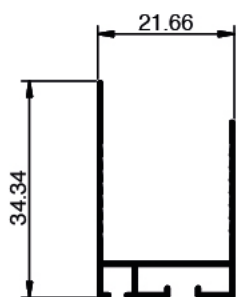

KW 05
Weight: 0.197 KG/M
INVISIBLE - PROFILE

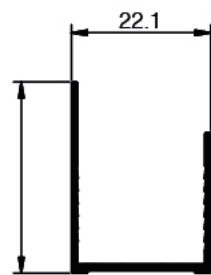

KW 06
Weight: 0.202 KG/M
U - PROFILE

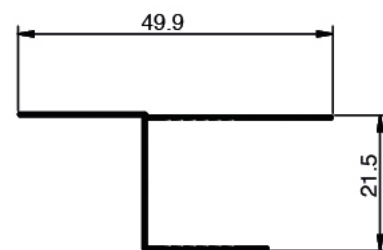

KW 07
Weight: 0.172 KG/M
CHAIR - PROFILE

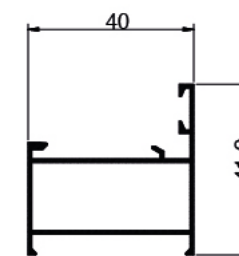

MR 465
Weight: 0.350 KG/M

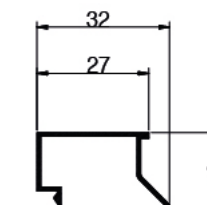

MR 498
Weight: 0.150 KG/M

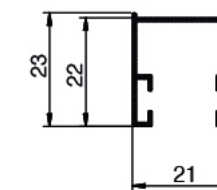

MR 432
Weight: 0.190 KG/M

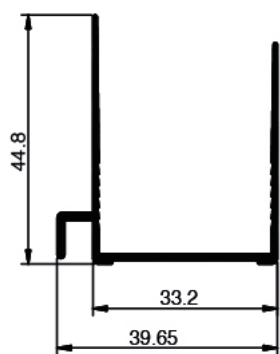

KW 08
Weight: 0.389 KG/M
JOINT - PROFILE

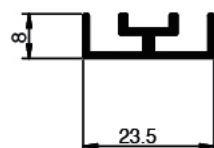

KW 09
Weight: 0.180 KG/M
SLIDE IN CHANNEL



KW 10
Weight: 0.300 KG/M
STIFFING ROD

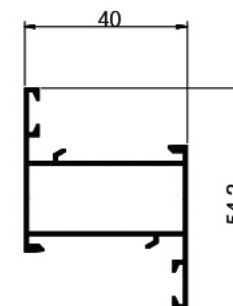

MR 461
Weight: 0.400KG/M

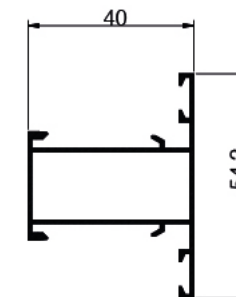

MR 462
Weight: 0.400 KG/M

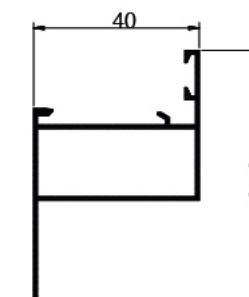

MR 463
Weight: 0.400 KG/M

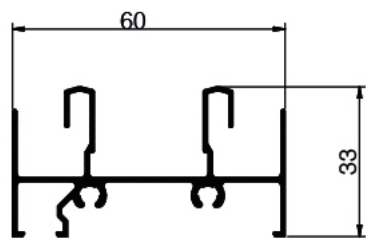

MR 326
Weight: 0.500 KG/M

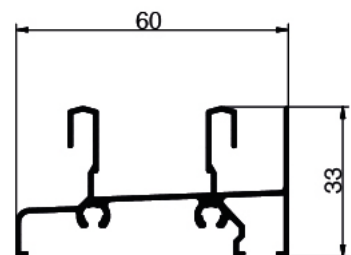

MR 327
Weight: 0.500 KG/M

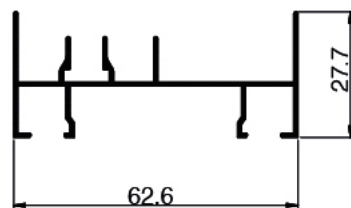

MR 325
Weight: 0.400 KG/M

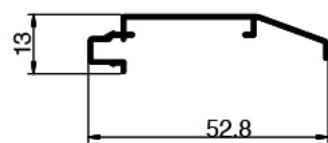

MR 407
Weight: 0.200 KG/M

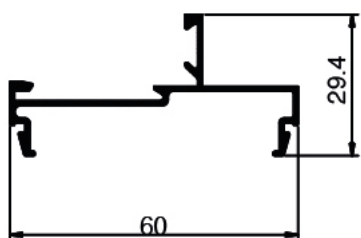

MR 468
Weight: 0.320 KG/M

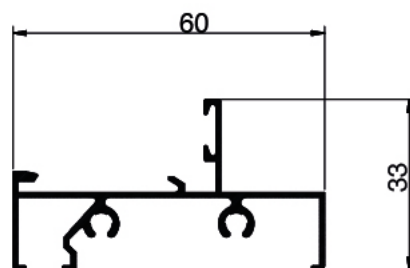

MR 467
Weight: 0.400 KG/M

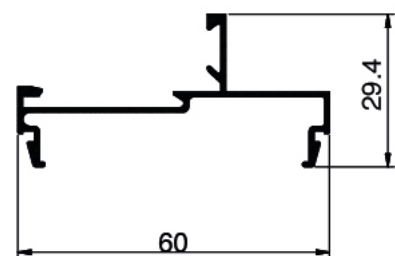

MR 468
Weight: 0.320 KG/M

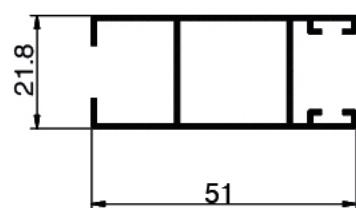

MR 412
Weight: 0.350 KG/M

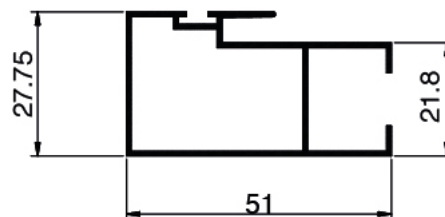

MR 410
Weight: 0.400 KG/M

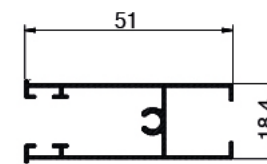

MR 652
Weight: 0.350 KG/M

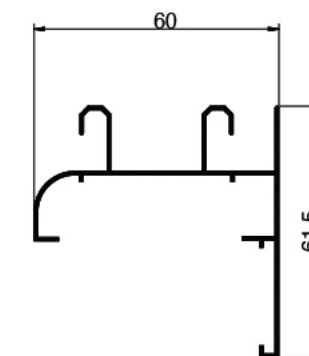

MR 413
Weight: 0.460 KG/M

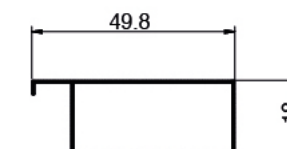

MR 250
Weight: 0.256 KG/M

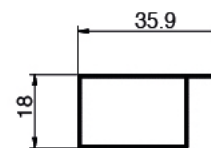

MR 251
Weight: 0.200 KG/M

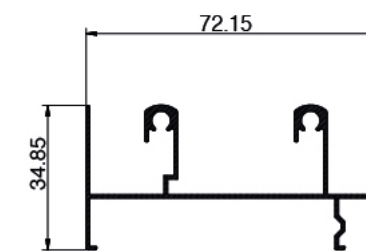

MR 224
Weight: 0.630 KG/M

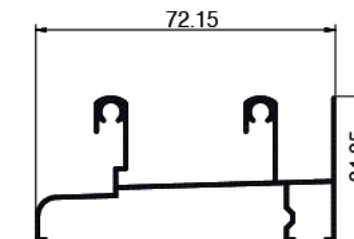

MR 225
Weight: 0.575 KG/M

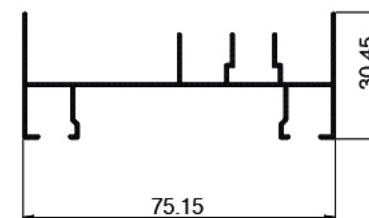

MR 226
Weight: 0.475KG/M

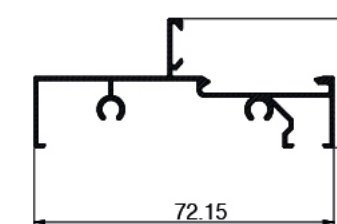

MR 227
Weight: 0.485 KG/M

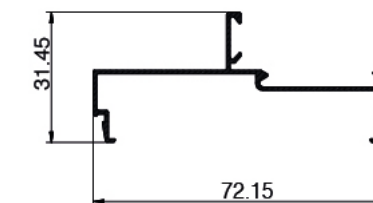

MR 228
Weight: 0.378 KG/M

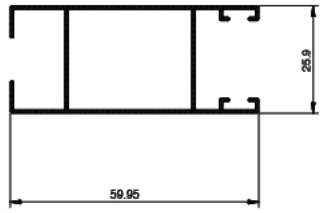

MR 234
Weight: 0.455 KG/M

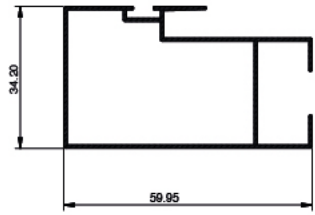

MR 235
Weight: 0.491 KG/M

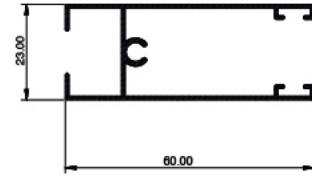

MR 236
Weight: 0.450 KG/M

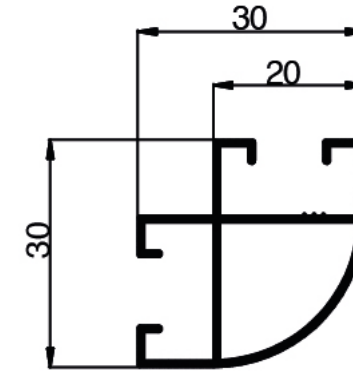

MR 304
Weight: 0.317 KG/M

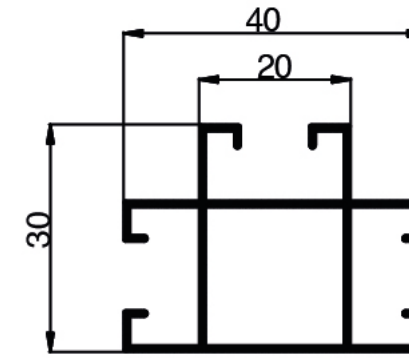

MR 305
Weight: 0.432 KG/M

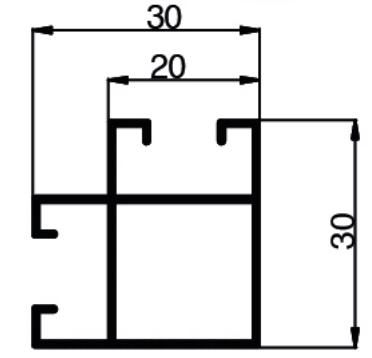

MR 306
Weight: 0.352 KG/M

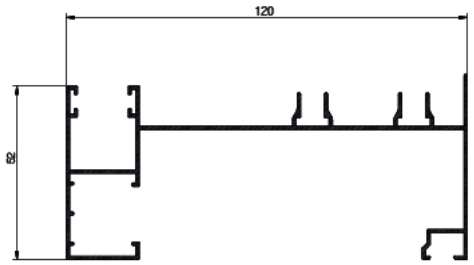

MR 266
Weight: 1.048 KG/M

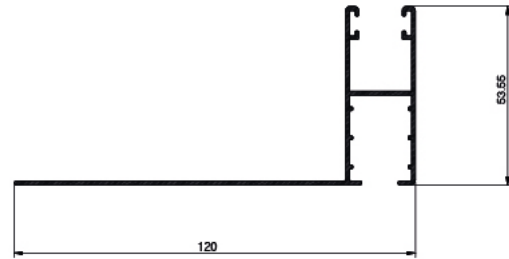

MR 602
Weight: 0.855 KG/M

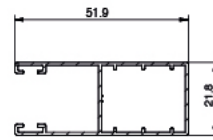

MR 601
Weight: 0.411 KG/M

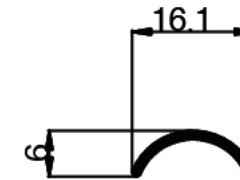

MR 307
Weight: 0.066 KG/M

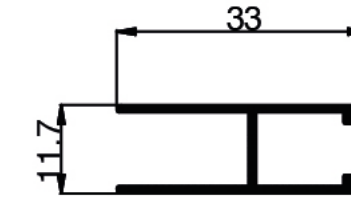

MR 308
Weight: 0.230 KG/M



MR 309
Weight: 0.626 KG/M

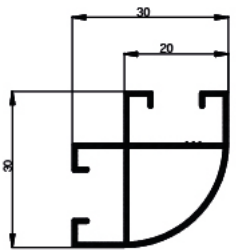

MR 301
Weight: 0.334 KG/M

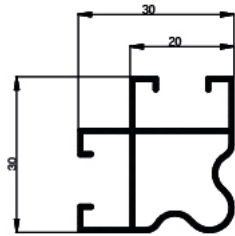

MR 302
Weight: 0.358 KG/M

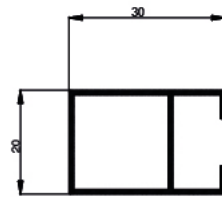

MR 303
Weight: 0.263 KG/M

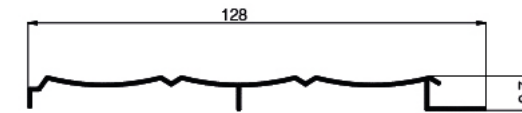

MR 401
Weight: 0.403 KG/M

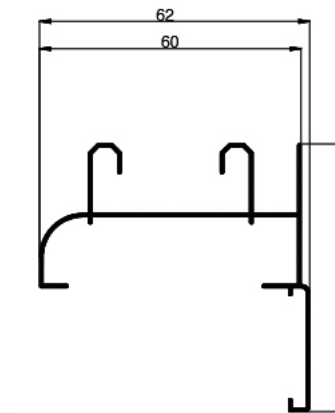

MR 249
Weight: 0.463 KG/M

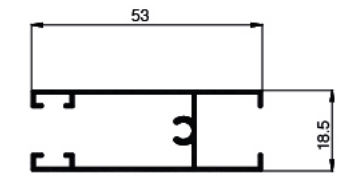

MR 253
Weight: 0.371 KG/M

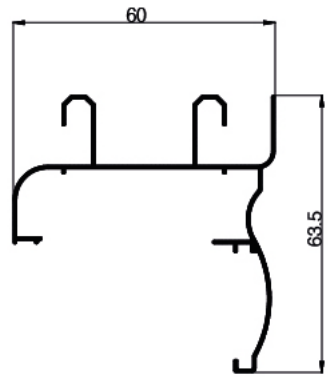

MR 255
Weight: 0.479 KG/M

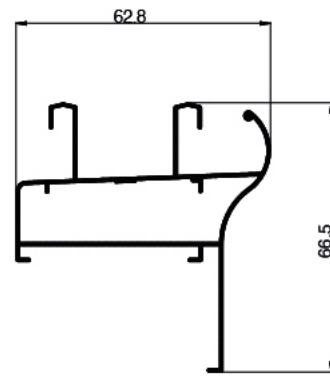

MR 262
Weight: 0.646 KG/M

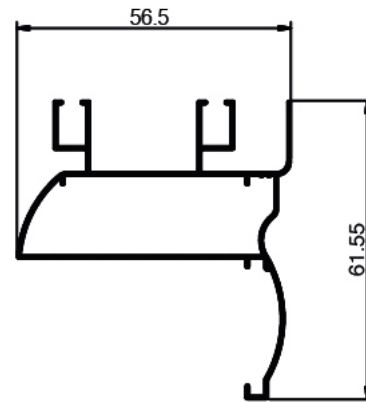

MR 661
Weight: 0.536 KG/M

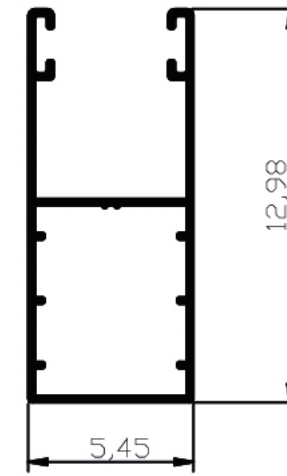

MR 602
Weight: 0.855 KG/M

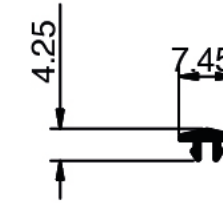

MR 662
Weight: 0.040 KG/M

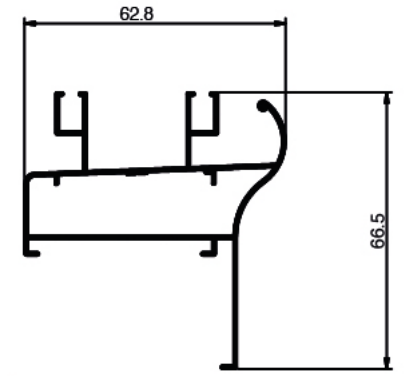

MR 663
Weight: 0.680 KG/M

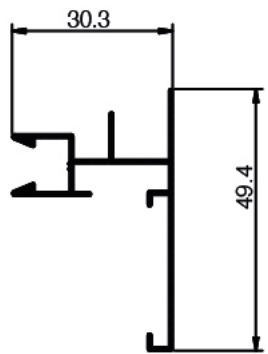

MR 665
Weight: 0.265 KG/M

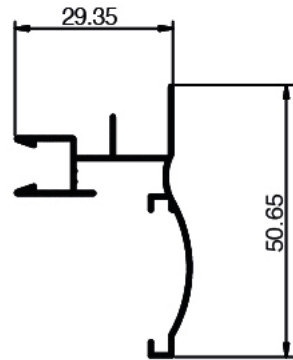

MR 666
Weight: 0.256 KG/M

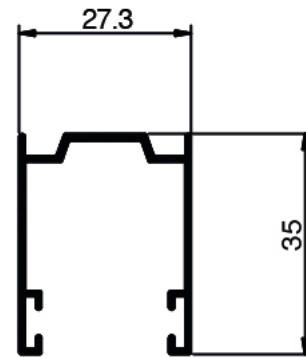

MR 667
Weight: 0.308 KG/M

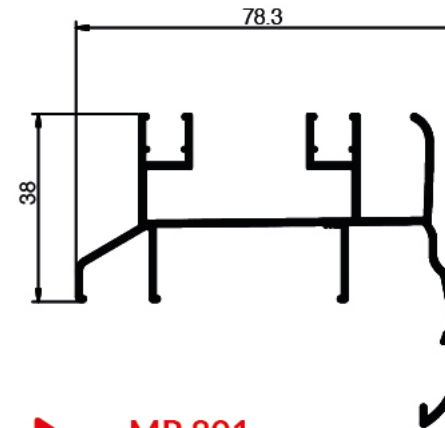

MR 801
Weight: 0.875 KG/M

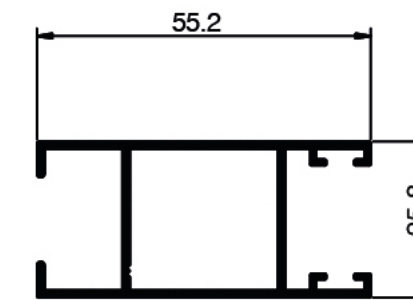

MR 802
Weight: 0.618 KG/M

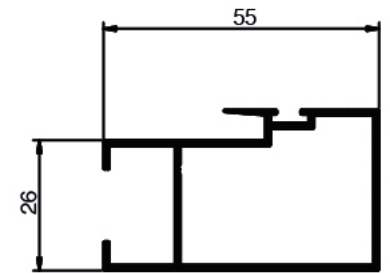

MR 803
Weight: 0.618 KG/M

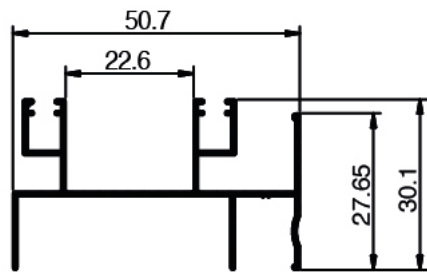

MR 668
Weight: 0.384 KG/M

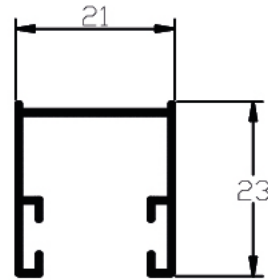

MR 432
Weight: 0.190 KG/M

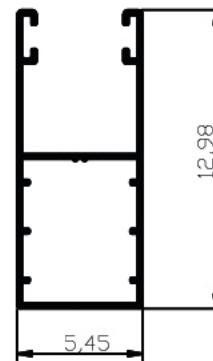

MR 601
Weight: 0.411 KG/M

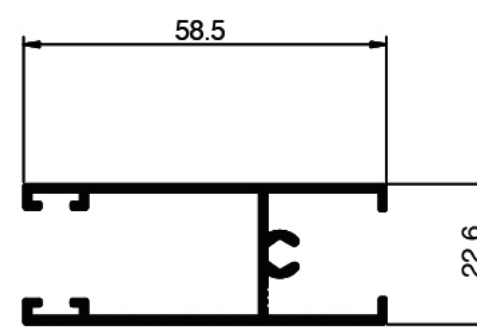

MR 804
Weight: 0.618 KG/M

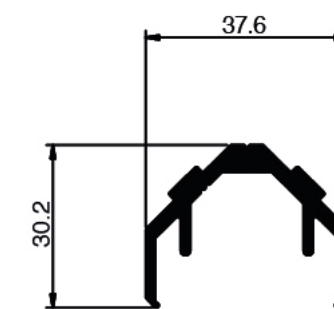

MR 805
Weight: 0.632 KG/M

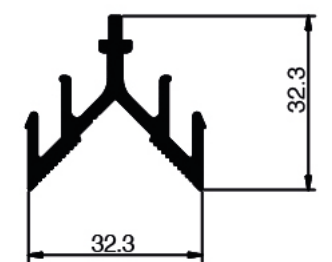

MR 806
Weight: 0.580 KG/M

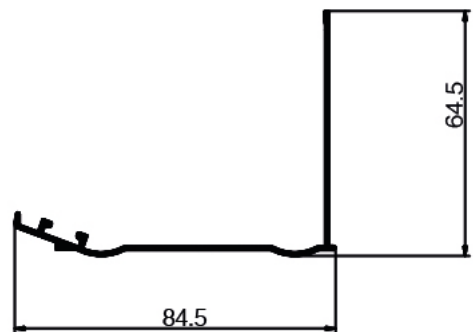

MR 807
Weight: 0.475 KG/M

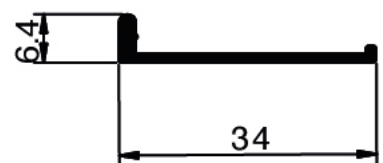

MR 901
Weight: 0.148 KG/M

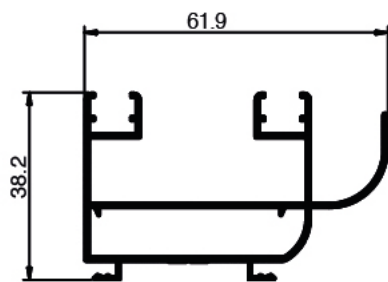

MR 902
Weight: 0.745 KG/M

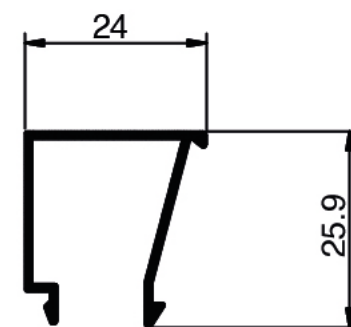

MR 913
Weight: 0.226 KG/M

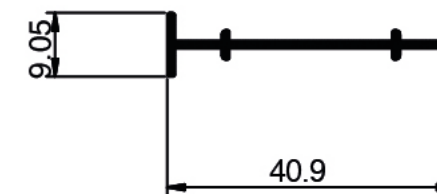

MR 914
Weight: 0.192 KG/M

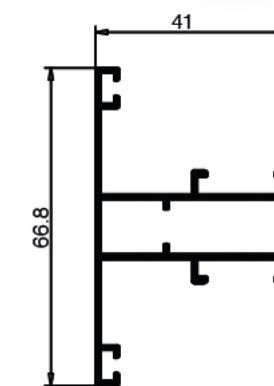

MR 701
Weight: 0.640 KG/M

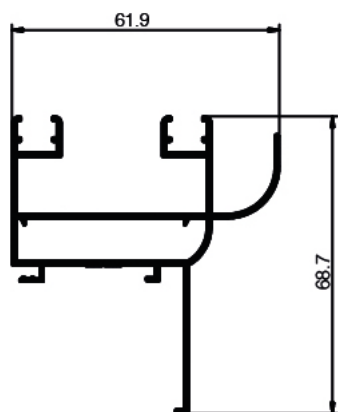

MR 903
Weight: 0.843 KG/M

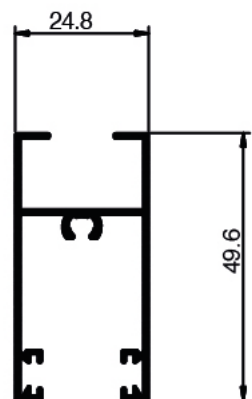

MR 905
Weight: 0.470 KG/M

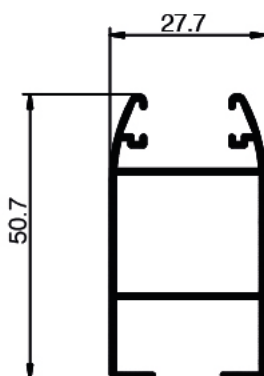

MR 909
Weight: 0.499 KG/M

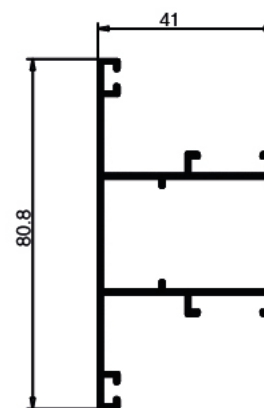

MR 702
Weight: 0.722 KG/M

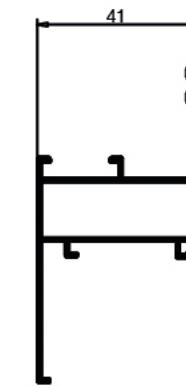

MR 703
Weight: 0.640 KG/M

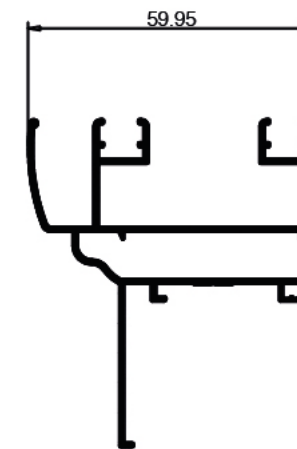

MR 704
Weight: 0.865 KG/M

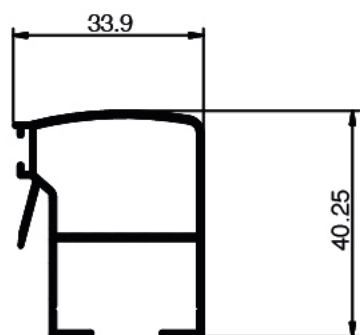

MR 910
Weight: 0.501 KG/M

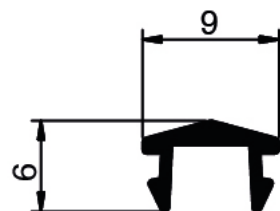

MR 911
Weight: 0.053 KG/M

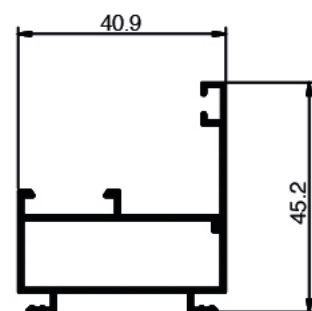

MR 912
Weight: 0.485 KG/M

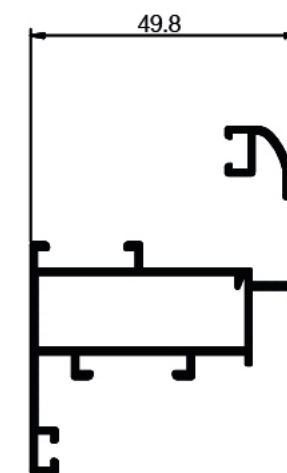

MR 705
Weight: 0.750 KG/M

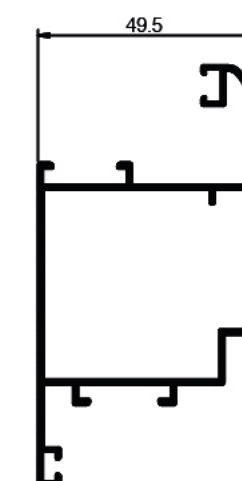

MR 709
Weight: 0.935 KG/M

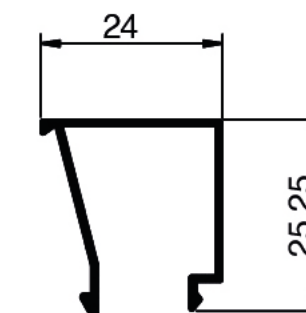

MR 707
Weight: 0.207 KG/M

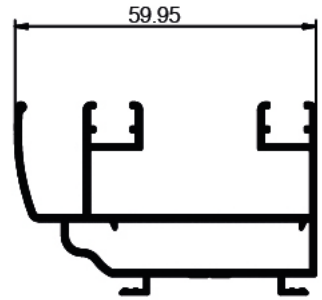

MR 708
Weight: 0.766 KG/M

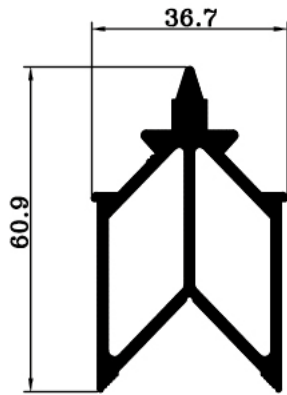

MR 1304
Weight: 1.245 KG/M

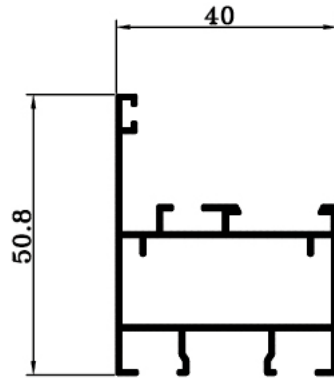

MR 1305
Weight: 0.566 KG/M

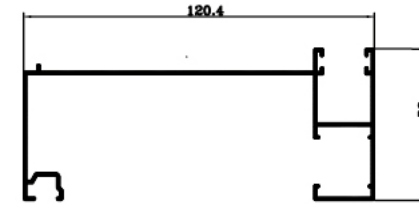

MR 1316
Weight: 0.823 KG/M

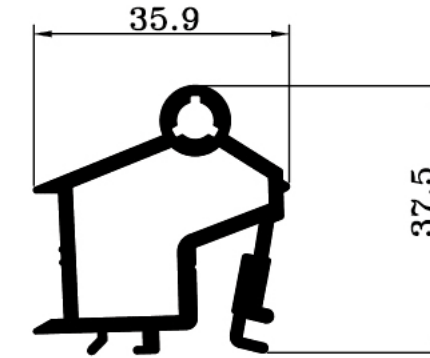

MR 1321
Weight: 0.830 KG/M

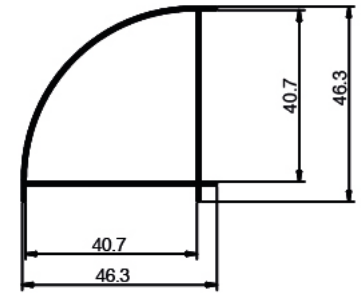

MR 310
Weight: 0.378 KG/M

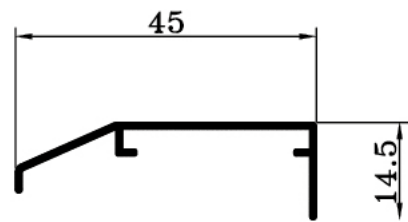

MR 1307
Weight: 0.184 KG/M

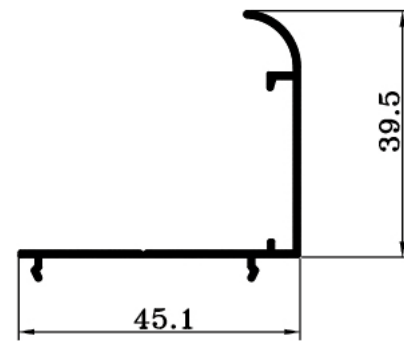

MR 1308
Weight: 0.268 KG/M

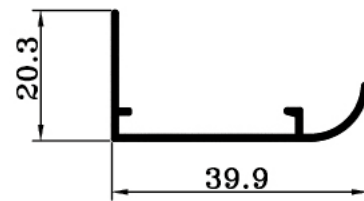

MR 1310
Weight: 0.188 KG/M

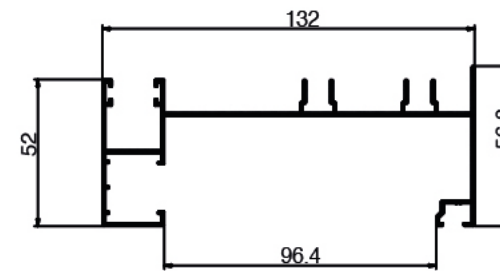

MR 267
Weight: 1.055 KG/M

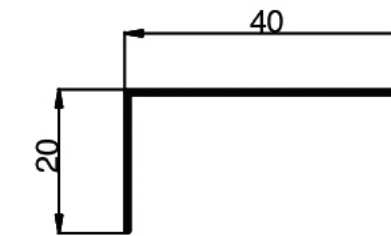

ST 2040
Weight: 0.150 KG/M

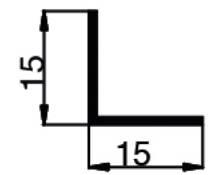

ST 3015 A
Weight: 0.078 KG/M

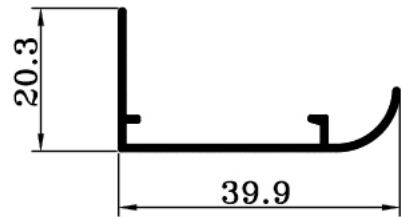

MR 1311
Weight: 0.155 KG/M

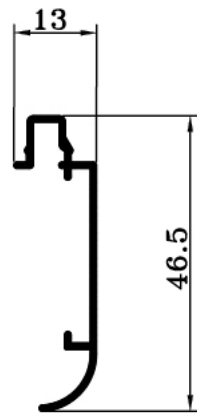

MR 1312
Weight: 0.208 KG/M

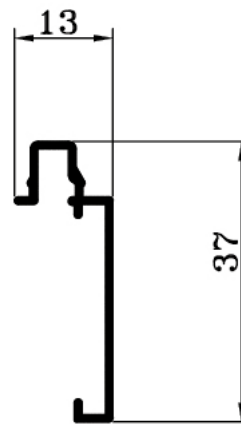

MR 1313
Weight: 0.175 KG/M

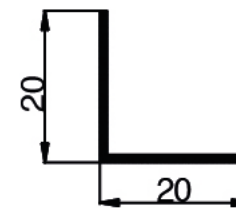

ST 3020 A
Weight: 0.105 KG/M

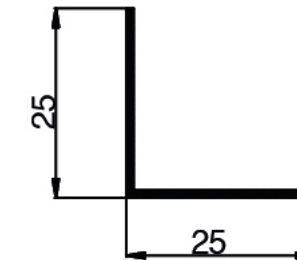

ST 3025
Weight: 0.132 KG/M

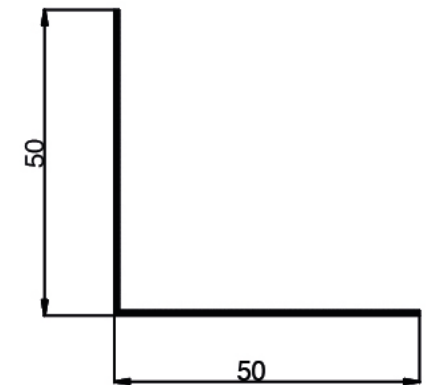

ST 3050
Weight: 0.205 KG/M

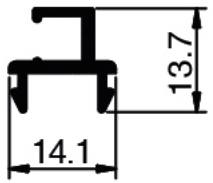

▶ HSB 01
Weight: 0.161 KG/M

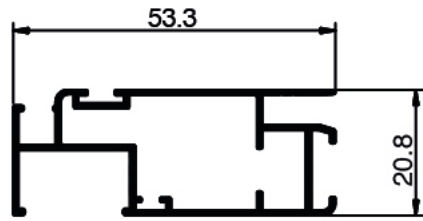

▶ HSB 01 A
Weight: 0.475 KG/M

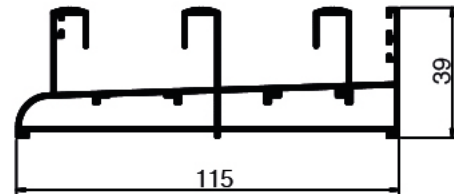

▶ HSB 06
Weight: 1.619 KG/M

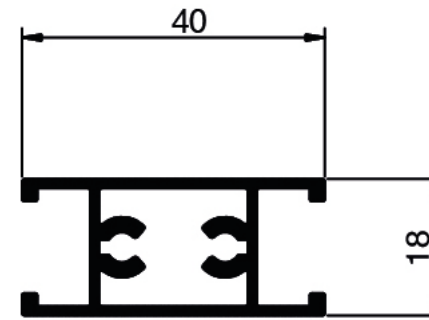

▶ HSB 19 C
Weight: 0.688 KG/M

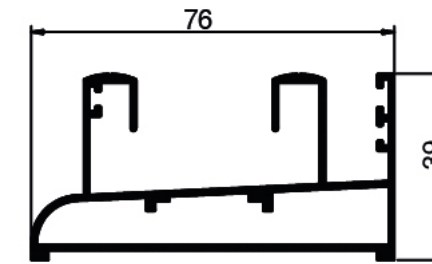

▶ HSB 27 B
Weight: 1.097 KG/M

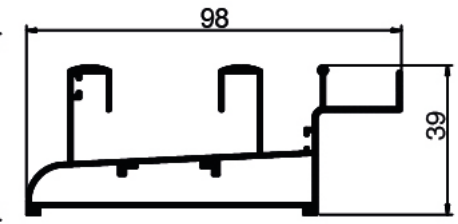

▶ HSB 27 C
Weight: 1.023 KG/M

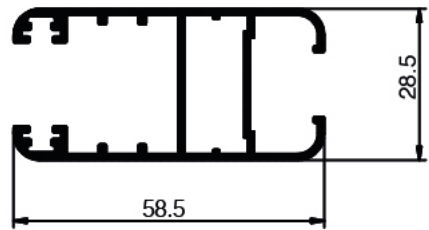

▶ HSB 07
Weight: 0.784 KG/M

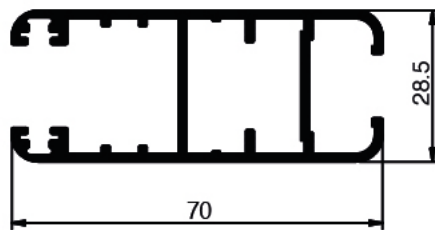

▶ HSB 07 B
Weight: 0.993 KG/M

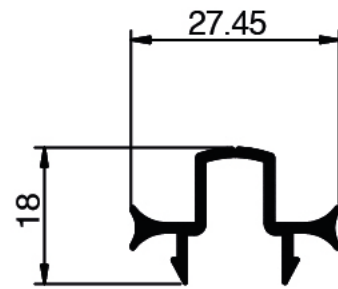

▶ HSB 14
Weight: 0.223 KG/M

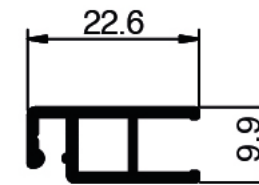

▶ HSB 36
Weight: 0.216 KG/M

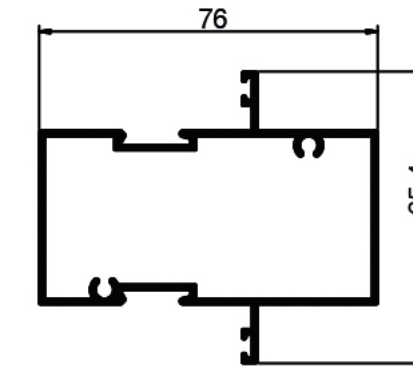

▶ HSB 40
Weight: 1.051 KG/M

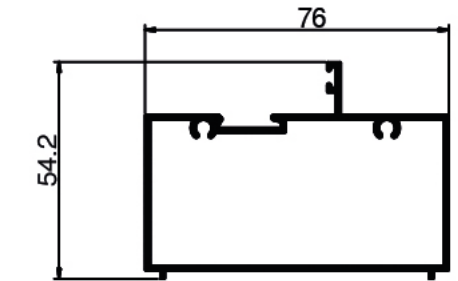

▶ HSB 41 A
Weight: 0.947 KG/M

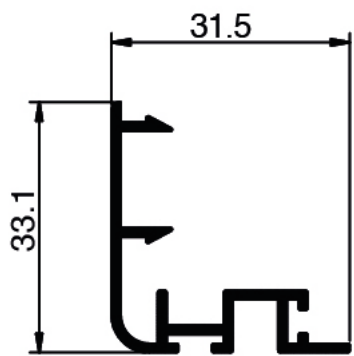

▶ HSB 15
Weight: 0.342 KG/M

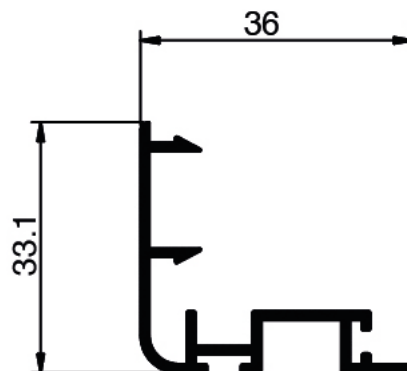

▶ HSB 15 A
Weight: 0.355 KG/M

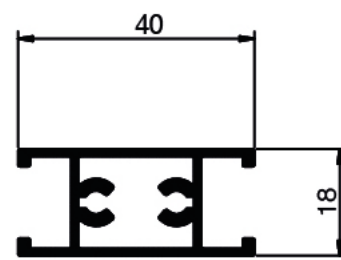

▶ HSB 19 A
Weight: 0.533 KG/M

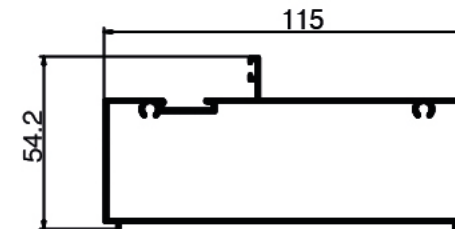

▶ HSB 41 B
Weight: 1.213 KG/M

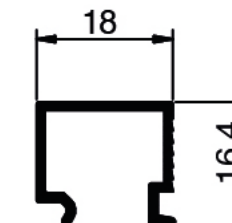

▶ HSB 42
Weight: 0.171 KG/M

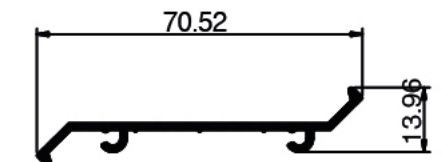

▶ HSB 43
Weight: 0.369 KG/M

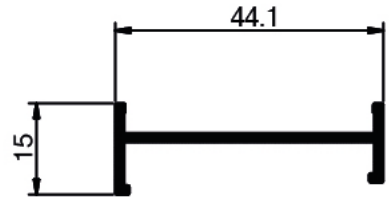

▶ HSB 46
Weight: 0.298 KG/M

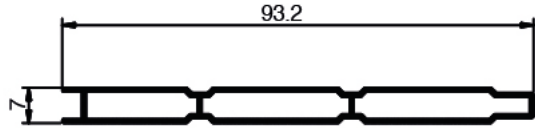

▶ HSB 09
Weight: 0.456 KG/M

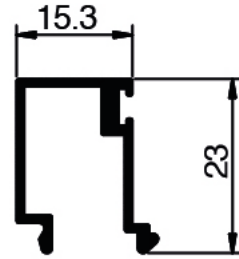

▶ HSB 13
Weight: 0.223 KG/M

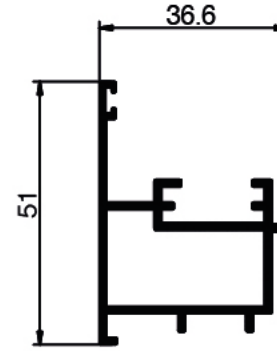

▶ HSB 26
Weight: 0.660 KG/M

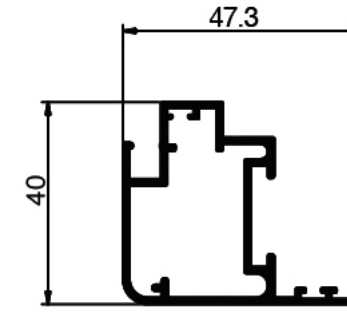

▶ HSB 27 B
Weight: 0.687 KG/M

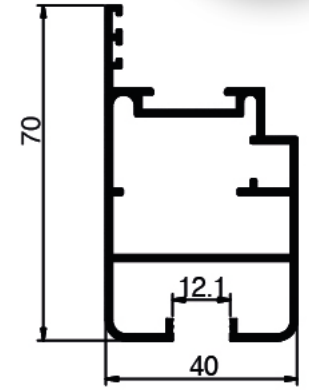

▶ HSB 17
Weight: 0.904 KG/M

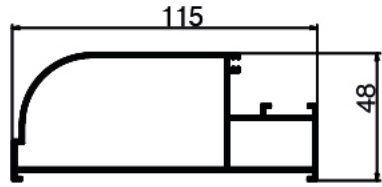

▶ HSB 18
Weight: 1.343 KG/M

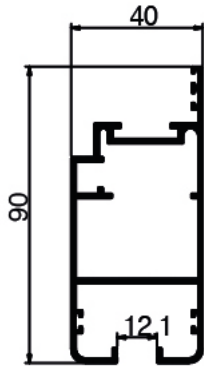

▶ HSB 20
Weight: 1.166 KG/M

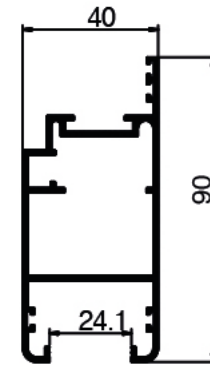

▶ HSB 21
Weight: 1.130 KG/M

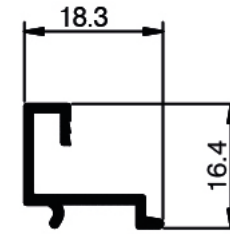

▶ HSB 42 B
Weight: 0.143 KG/M

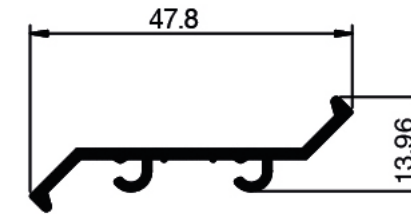

▶ HSB 43 B
Weight: 0.275 KG/M

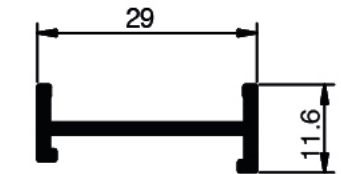

▶ HSB 46 A
Weight: 0.216 KG/M

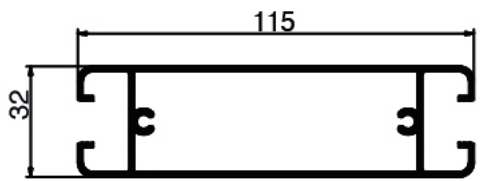

▶ HSB 22
Weight: 1.376 KG/M

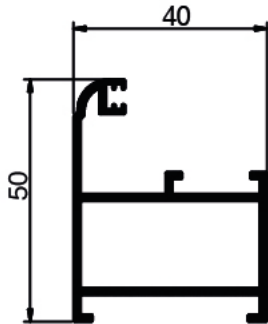

▶ HSB 24 A
Weight: 0.748 KG/M

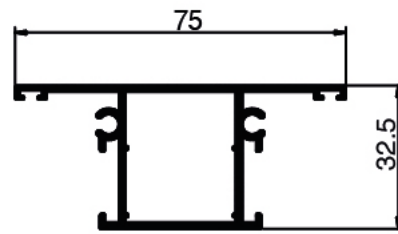

▶ HSB 25
Weight: 0.835 KG/M

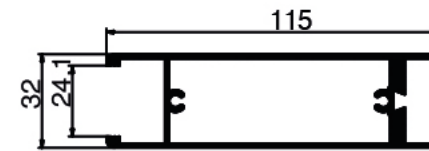

▶ HSB 31 A
Weight: 1.559 KG/M

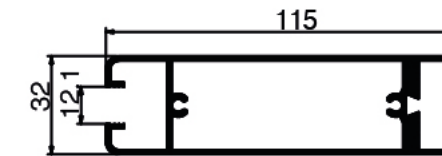

▶ HSB 31 B
Weight: 1.602 KG/M

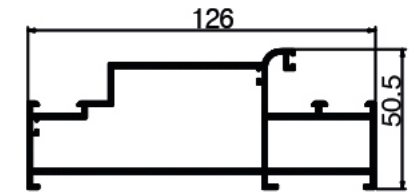

▶ HSB 51
Weight: 1.695 KG/M

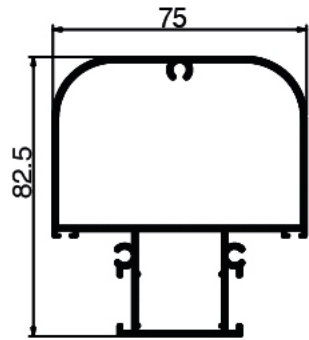

▶ HSB 52
Weight: 1.518 KG/M

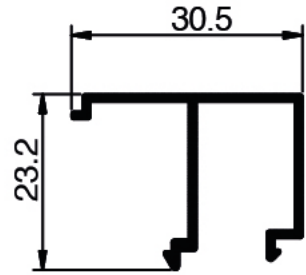

▶ HSB 54
Weight: 0.231 KG/M

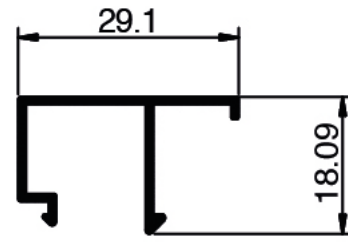

▶ HSB 55A
Weight: 0.191 KG/M

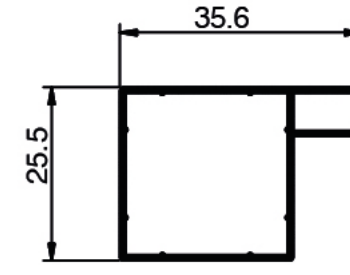

▶ C2
Weight: 0.288 KG/M

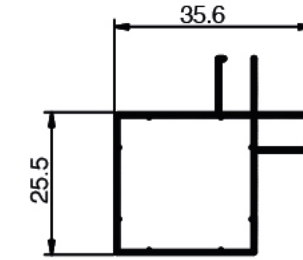

▶ C3
Weight: 0.324 KG/M

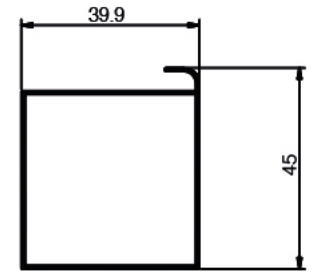

▶ C4
Weight: 0.365 KG/M

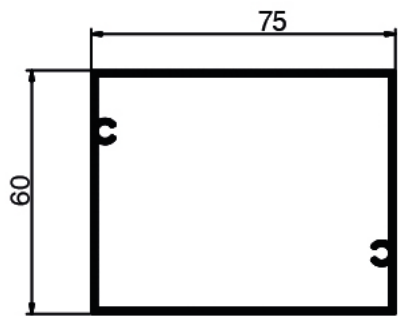

▶ HSB 56 A
Weight: 1.139 KG/M

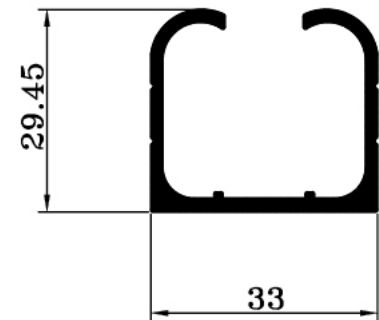

▶ YAM01
Weight: 0.535 KG/M

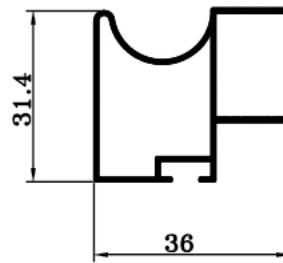

▶ YAM02
Weight: 0.332 KG/M

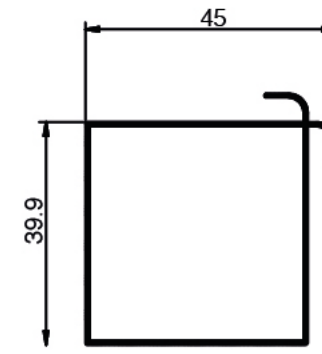

▶ C5
Weight: 0.385 KG/M

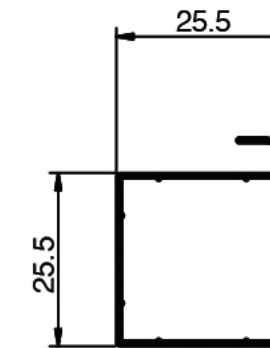

▶ C6
Weight: 0.255 KG/M

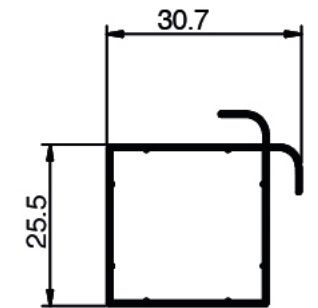

▶ C7
Weight: 0.279 KG/M

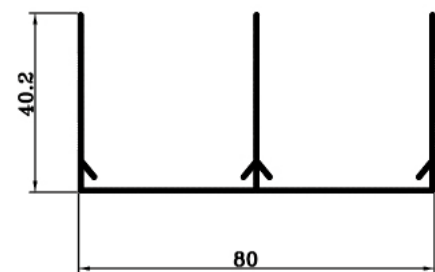

▶ YAM03
Weight: 0.535 KG/M

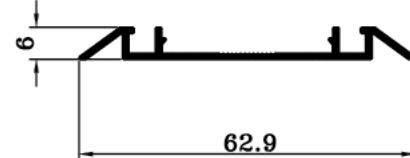

▶ YAM04
Weight: 0.268 KG/M

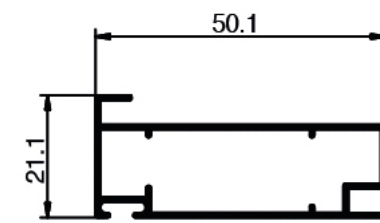

▶ C1
Weight: 0.365 KG/M

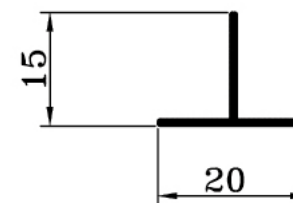

▶ C8
Weight: 0.089 KG/M

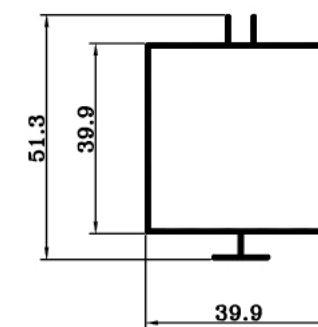

▶ C9
Weight: 0.455 KG/M

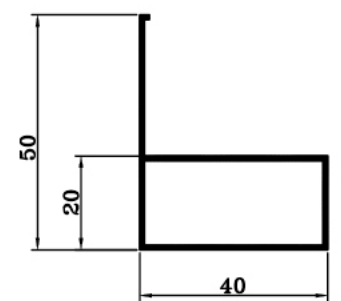

▶ C12
Weight: 0.400 KG/M

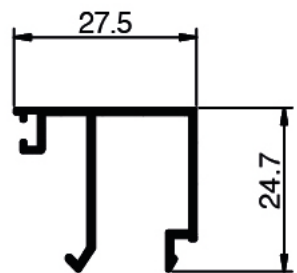

▶ 501
Weight: 0.265 KG/M

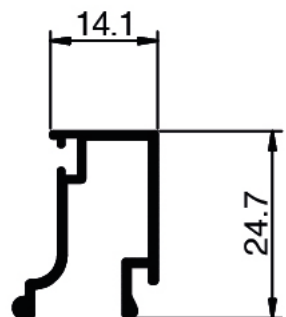

▶ 502
Weight: 0.229 KG/M

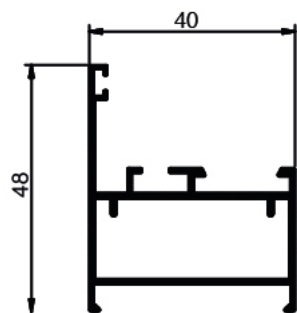

▶ HSB 511
Weight: 0.545 KG/M

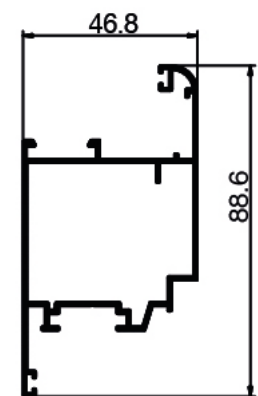

▶ 514
Weight: 0.855 KG/M

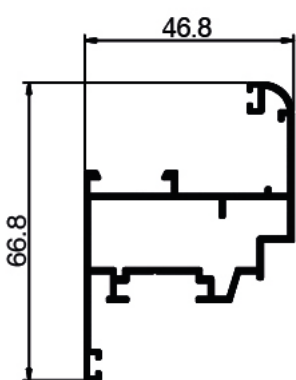

▶ 515
Weight: 0.730 KG/M

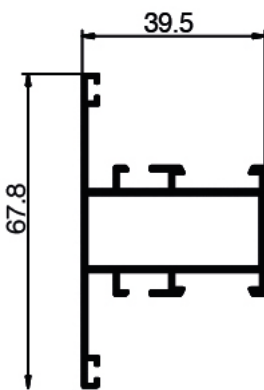

▶ 516
Weight: 0.680 KG/M

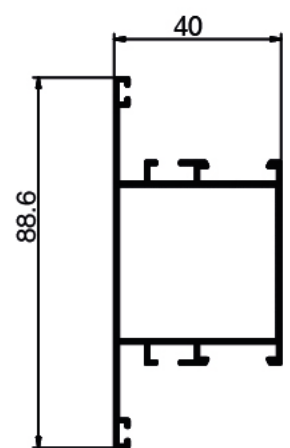

▶ 517
Weight: 0.780 KG/M

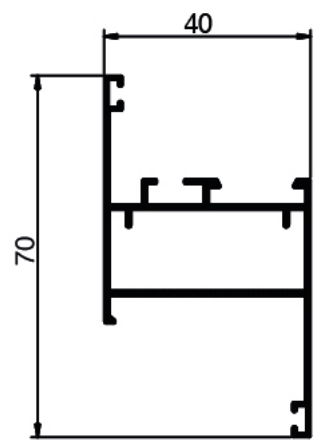

▶ 548
Weight: 0.625 KG/M

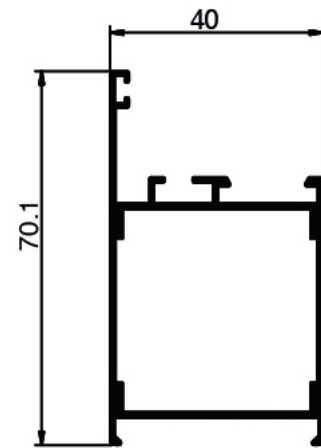

▶ 903
Weight: 0.735 KG/M

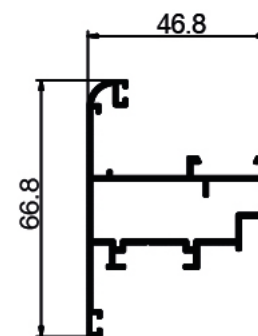

▶ 1.014
Weight: 0.721 KG/M

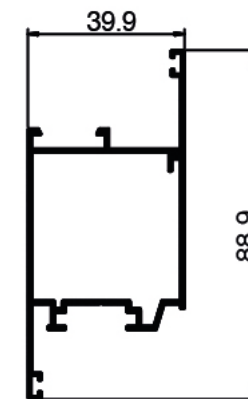

▶ 1.070
Weight: 0.785 KG/M

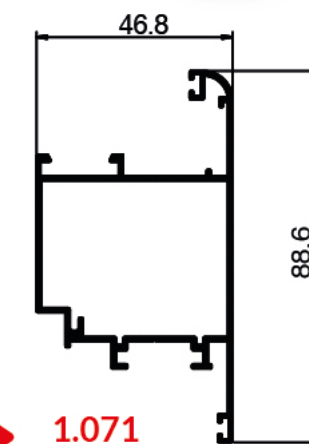

▶ 1.071
Weight: 0.857 KG/M

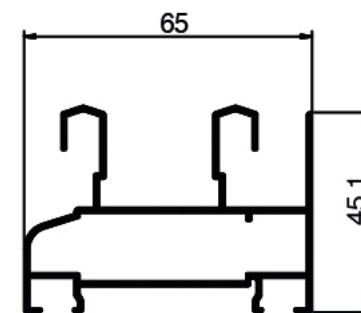

▶ 1.156
Weight: 0.883 KG/M

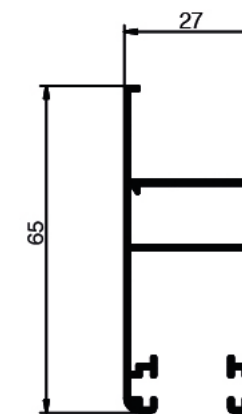

▶ 1.157
Weight: 0.665 KG/M

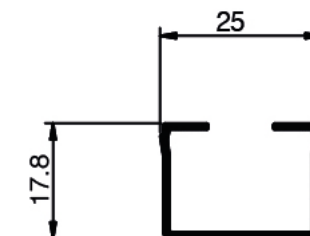

▶ 1.159
Weight: 0.159 KG/M

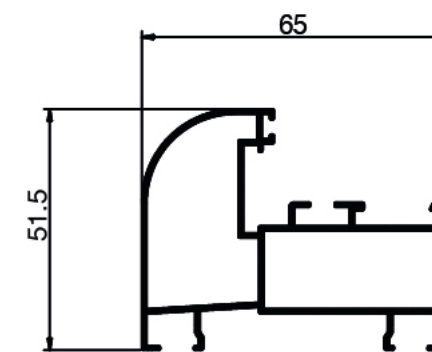

▶ 1.161
Weight: 0.840 KG/M

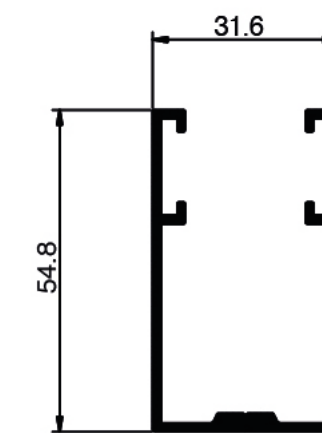

▶ 1200
Weight: 0.702 KG/M

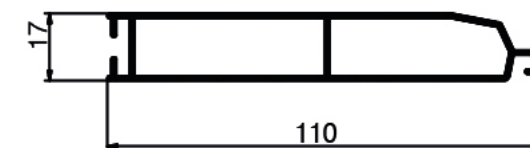

▶ 1201
Weight: 0.875 KG/M

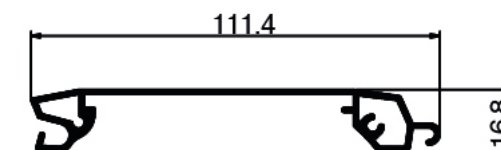

▶ 1202
Weight: 0.730 KG/M

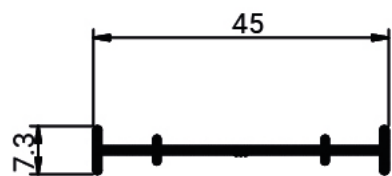

▶ 3637
Weight: 0.213 KG/M

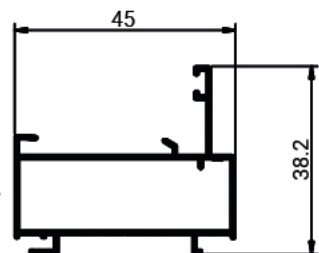

▶ 3937
Weight: 0.440 KG/M

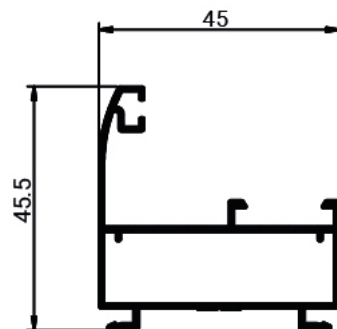

▶ S 4003
Weight: 0.545 KG/M

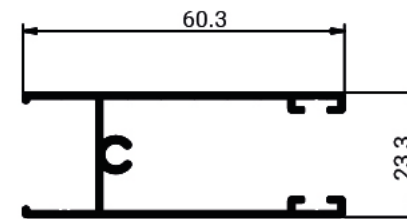

▶ MR 1301
Weight: 0.518 KG/M

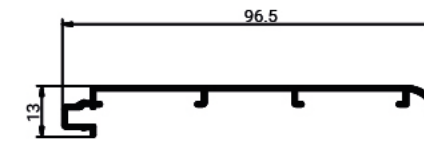

▶ MR 1314
Weight: 0.440 KG/M

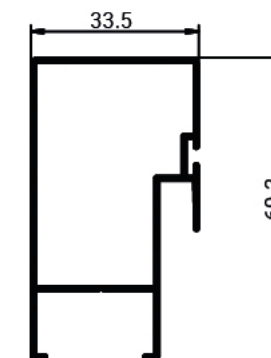

▶ MR 1302
Weight: 0.559 KG/M

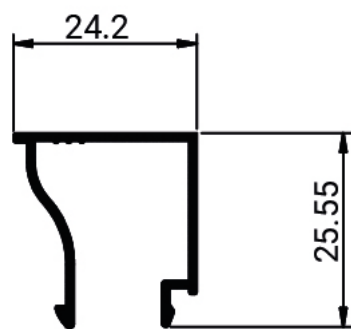

▶ S 4008
Weight: 0.235 KG/M

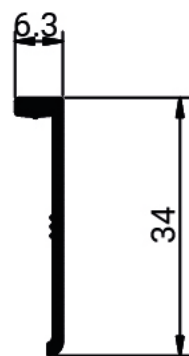

▶ S 5002
Weight: 0.159 KG/M

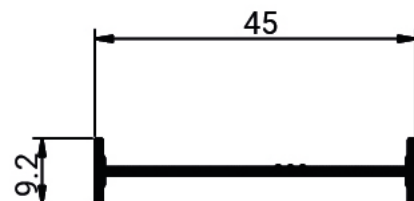

▶ S 5004
Weight: 0.208 KG/M

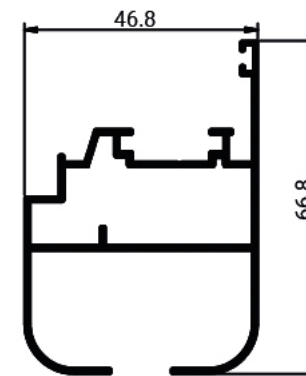

▶ MR 1315
Weight: 0.804 KG/M

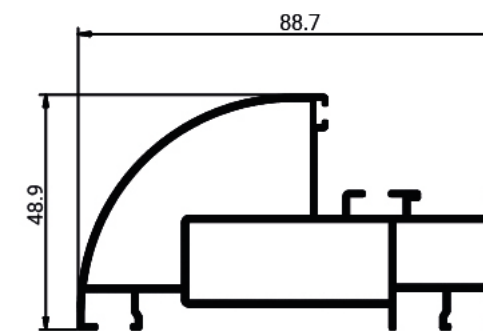

▶ MR 1317
Weight: 1.180 KG/M

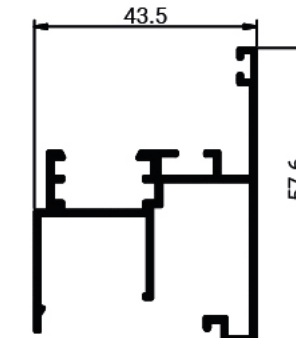

▶ MR 1318
Weight: 0.685 KG/M

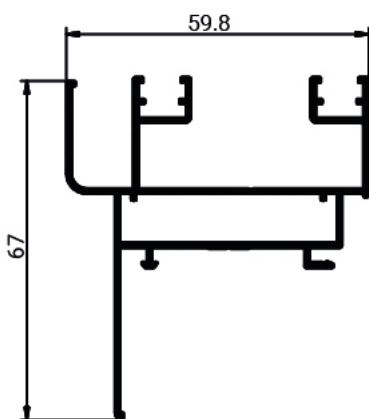

▶ CONGO 01
Weight: 0.865 KG/M

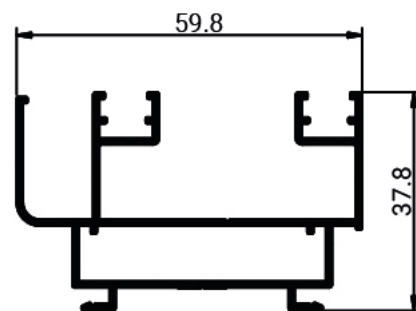

▶ CONGO 02
Weight: 0.775 KG/M

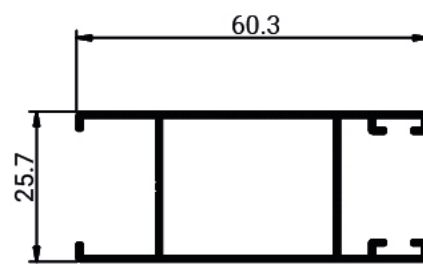

▶ MR 1300
Weight: 0.515 KG/M

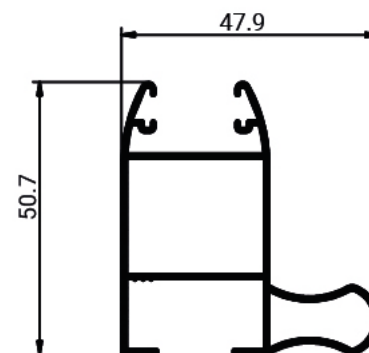

▶ MR 3357
Weight: 0.632 KG/M

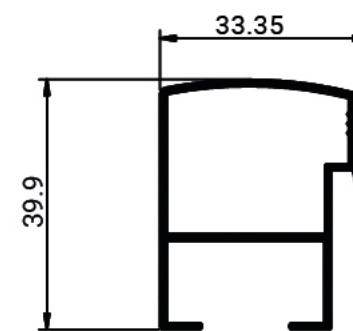

▶ MR 3437
Weight: 0.486 KG/M

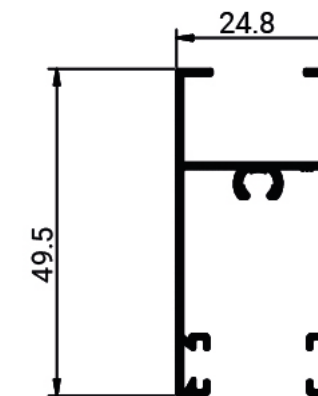

▶ MR 3537
Weight: 0.470 KG/M



OUR LOCATIONS

HEAD OFFICE

 6 Boutrous Ghali Street, Roxy, Heliopolis ,Cairo. Egypt.

 +202- 22588451

 +202- 22588452

FACTORY

 Lot # 164 To 169 Industrial Area Extension,
6th of October City, Giza, Egypt

 +202- 238337709 / +202- 238337710

 +202- 38313474

 info@caluminium.com

 www.caluminium.com

